

## 2. Module Variations

### 2.1 Standard modules and its variations

#### Example 800 mm cabinet

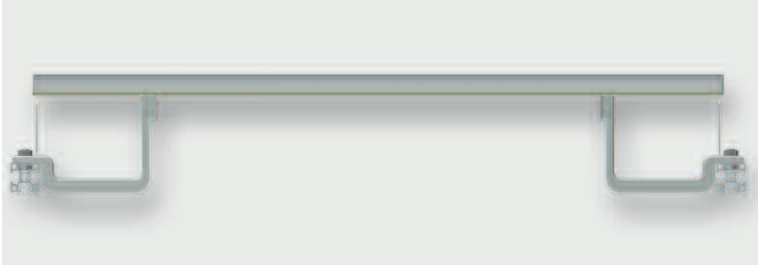

Standard			
Frame width C (mm)	Rail length A (mm)	Frame depth D (mm)	Wiring space B (cm <sup>2</sup> )
750	700	120	85

**Standard module:**

This option allows best wiring access and large capacity for wiring.

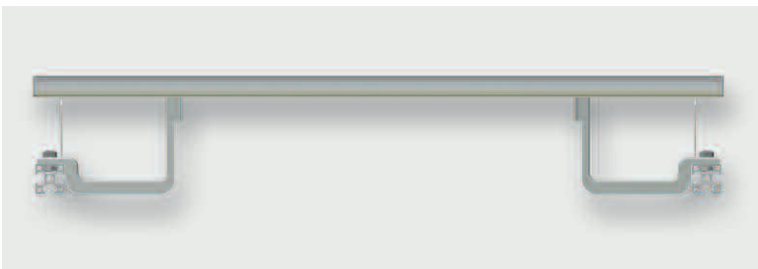

Option 1			
Frame width C (mm)	Rail length A (mm)	Frame depth D (mm)	Wiring space B (cm <sup>2</sup> )
700	700	120	85

**Option 1:**

Offers reduced wiring access, same capacity but allows frame to be mounted at the back of the cabinet. The mounting position allows for larger components as it can be mounted directly at the rear.

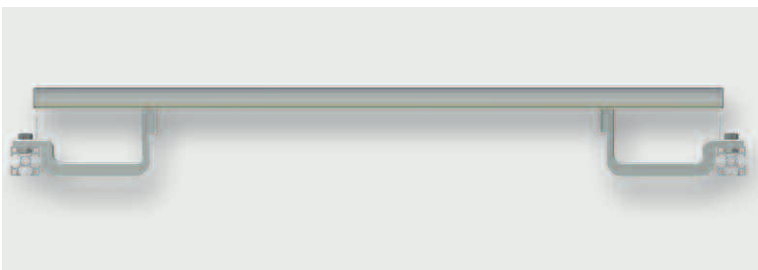

Option 2			
Frame width C (mm)	Rail length A (mm)	Frame depth D (mm)	Wiring space B (cm <sup>2</sup> )
750	700	90	55

**Option 2:**

This option provides optimum wiring access but does have a reduced capacity for wiring.

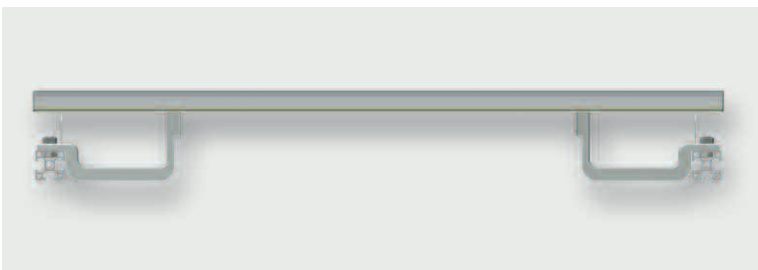

Option 3			
Frame width C (mm)	Rail length A (mm)	Frame depth D (mm)	Wiring space B (cm <sup>2</sup> )
700	700	90	55

**Option 3:**

Final option offers reduced wiring access and reduced capacity for wiring. The mounting position allows for larger components as it can be mounted directly at the rear.

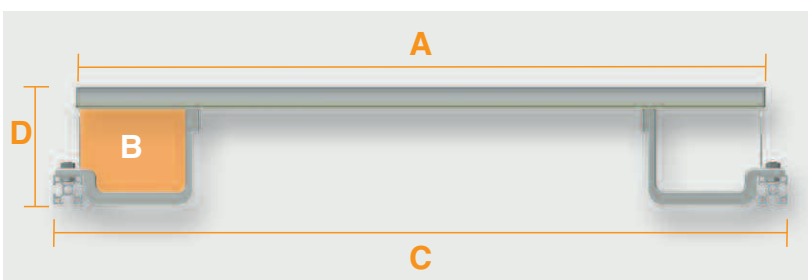

- A** = Rail length
- B** = Wiring space
- C** = Frame width
- D** = Frame depth

# 4. Mounting - Dimensions

## 4.1 Installation Dimensions for Rittal/Lohmeier ADWS 380681/380683

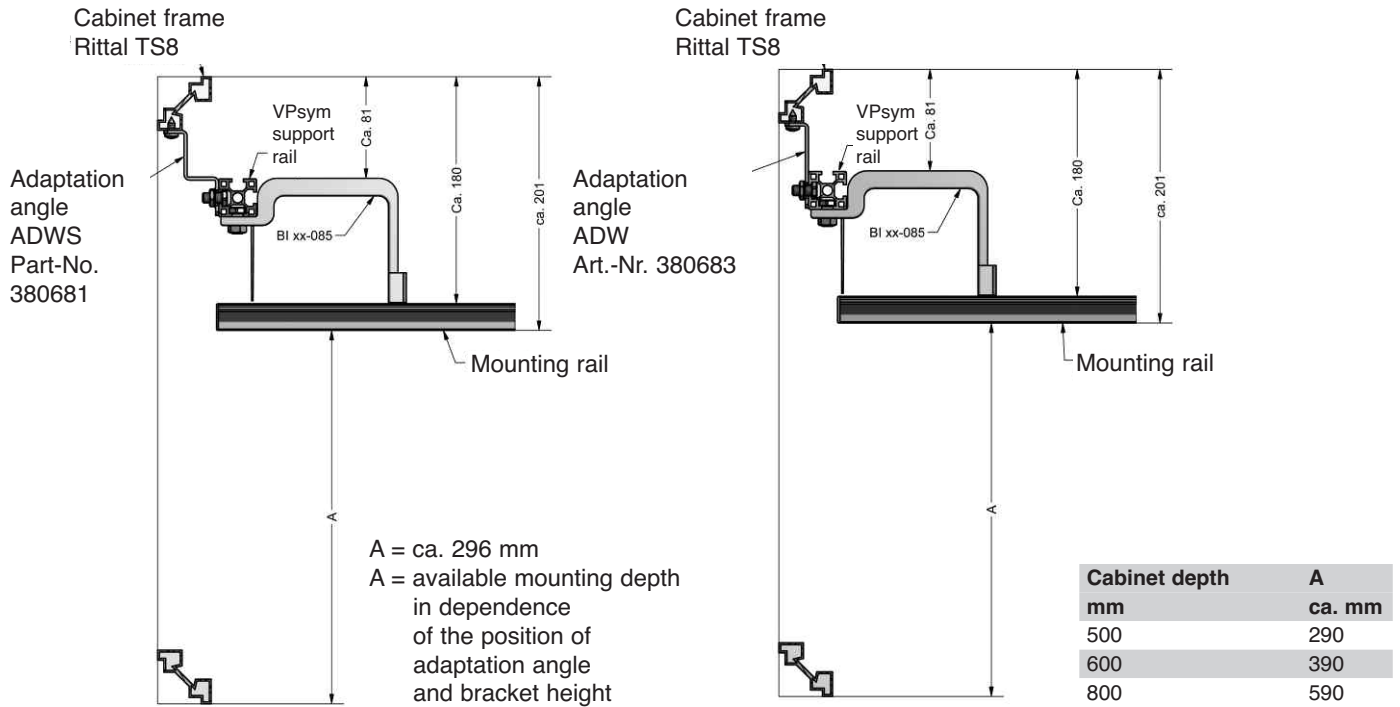

## 4.2 Installation Dimensions for Rittal ADWS 347552

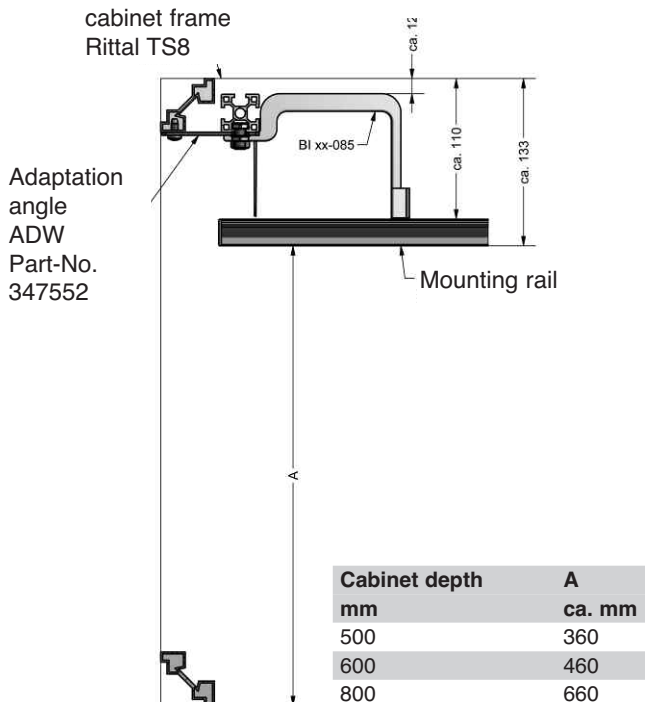

## 4.2 Dimensions Screw Channel

